

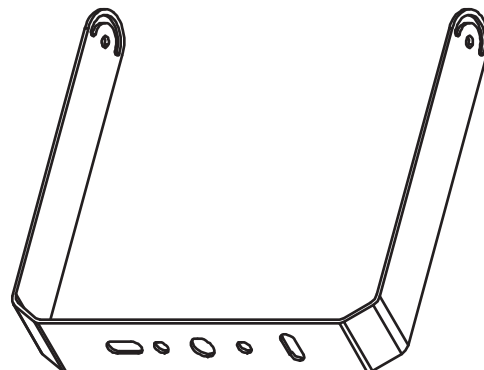

# Support TU

# TPALTU2BK

Pour TPAL 300W



## Dimensions

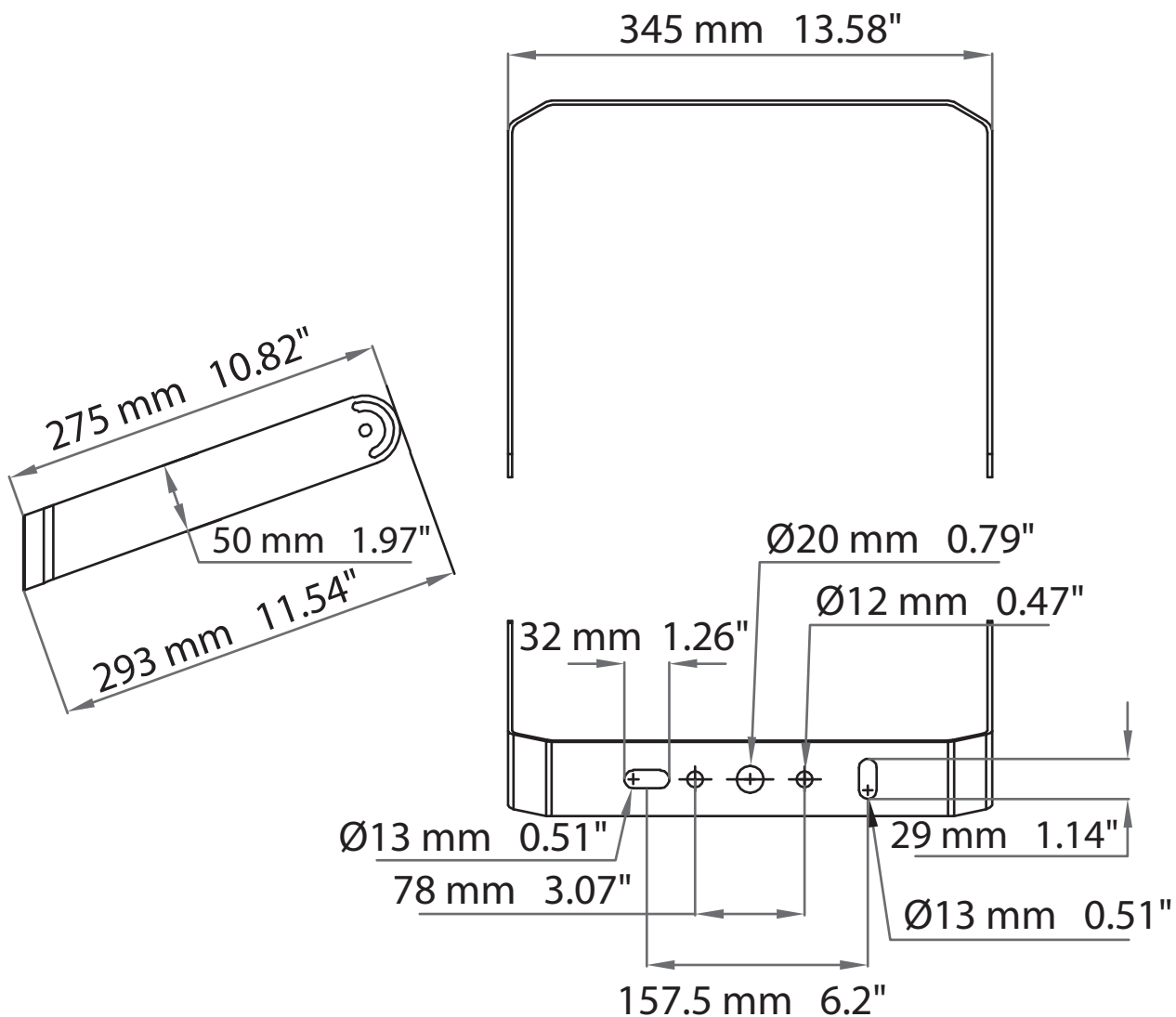

[info@technilight.ca](mailto:info@technilight.ca)

[WWW.TECHNILIGHT.CA](http://WWW.TECHNILIGHT.CA)

Photos à titre indicatif seulement rev 2.3.9