

INSTALLATION INSTRUCTIONS

LED STRIP LIGHT

Read this instruction carefully before installation. Keep it for further reference. Make electrical and grounded connections in accordance with the national electrical code and any applicable code. Always turn off the power supply before installation. This product must be installed in accordance with the applicable installation code by a qualified electrician who is familiar with the construction and operation of the product and the hazards involved.

⚠ WARNING:

- Risk of fire or electric shock. Fixture installation requires knowledge of luminaires electrical systems. If not qualified, DO NOT attempt installation. Contact a qualified electrician.
- Risk of fire or electric shock. Suitable for wet locations. Always turn off the power supply before installation. Risk of fire or electric shock. Suitable for non-insulated surface and frame. DO NOT cover fixture with insulation liner or similar material.
- DO NOT install fixture on unstable, loose or easily breakable surface. DO NOT exert force on the surface of the fixture.

Attention:

4F and 8F need to buy separate connector to complete the series connection function.







For connecting the series led tube power will be different so it needs to calculate the power value in advance.

Note:Suggest max connection quantity:

4FT strip light 15 pieces;

8FT strip light 10 pcs.

Strip light continuous row mounting-installation accessory:

Item	Ceiling plate	Hook	Wiring cap	Anchoring	Screw	Small screw
Photo						
8FT	2PCS	2PCS	3PCS	4PCS	4PCS	2PCS

Surface Mounted Installation:

1. Turn off the power.

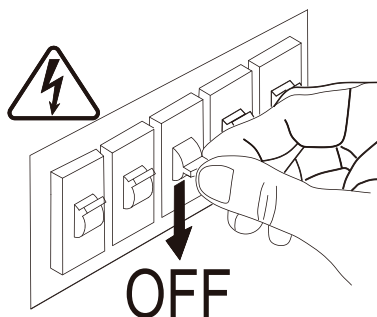

2. Screwed off the knockout hole at the end of lamp body.

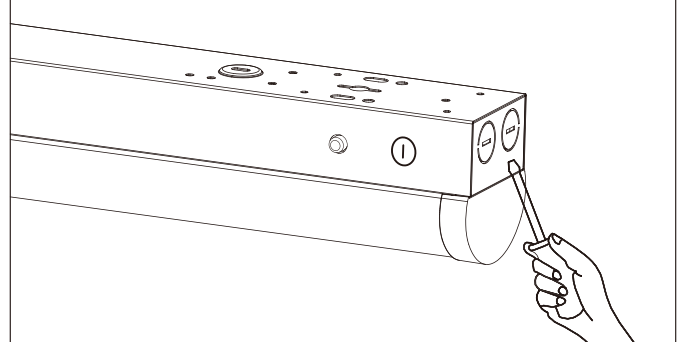

INSTALLATION INSTRUCTIONS

LED STRIP LIGHT

3. Drill holes at a suitable position on the wall and drive the expansion screw into the wall.

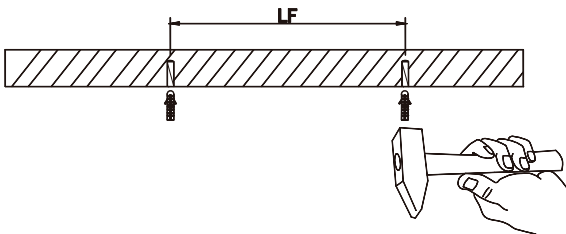

4. Use a screwdriver to tighten the screws to fix the lamp body on the wall.

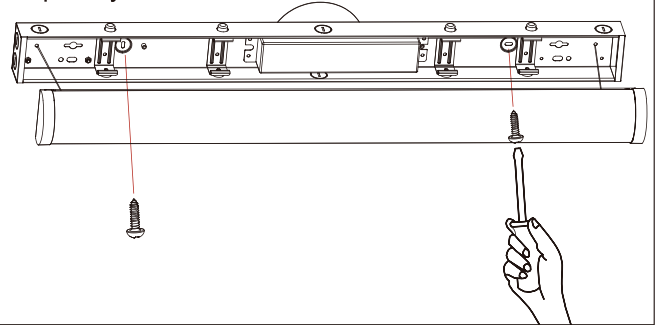

Sensor installation:

1. Secure the induction hook and tighten the screws

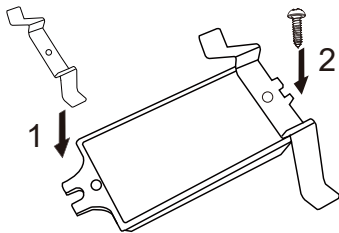

2. Fix the sensor in the lampshade

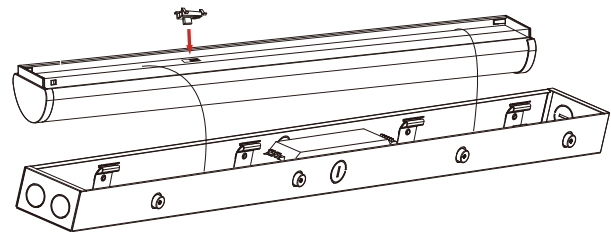

2. Connect the sensor cable to the power box cable

