



INSTALLATION INSTRUCTIONS FOR COMMERCIAL DOWNLIGHT

READ INSTRUCTIONS AND REVIEW ALL DIAGRAMS BEFORE INSTALLING THE FIXTURE. KEEP THESE INSTRUCTIONS FOR FUTURE REFERENCE.

IMPORTANT READ CAREFULLY BEFORE INSTALLING FIXTURE. RETAIN THESE INSTRUCTIONS FOR FUTURE REFERENCE.

This fixture must be wired in accordance with the National Electrical Code and all applicable local codes. Proper grounding is required for safety. THIS PRODUCT MUST BE INSTALLED IN ACCORDANCE WITH THE APPLICABLE INSTALLATION CODE BY A PERSON FAMILIAR WITH THE CONSTRUCTION AND OPERATION OF THE PRODUCT AND THE HAZARDS INVOLVED.

WARNINGS:

Risk of electrical shock. Disconnect power at fuse or circuit breaker before installing or servicing.

- To prevent early lamp failure, lamp should only be installed in operating environments ranging between -30°C and +40°C (-22°F and +104°F).
- No user serviceable parts inside. To avoid electrical shock do not disassemble product.
- WARNING- Risk of re or electric shock, LED Retrofit Kit installation requires knowledge of luminaires electrical systems. If not qualified, do not attempt installation. Contact a qualified electrician.
- WARNING- Risk of re or electric shock, Install this kit only in luminaires that have the construction features and min dimensions shown in the Template and where the input rating of the retrofit kit does not exceed the input rating of the luminaire.
- Do not make or alter any open holes in an enclosure of wiring or electrical components during kit installation
- WARNING- To prevent wiring damage or abrasion, do not expose wiring to edges of sheet metal or other sharp objects.
- Installers should not disconnect existing wires from lampholder terminals to make new connections at lampholder terminals. Instead installers should cut existing lampholder leads away from the lampholder and make new electrical connections to lampholder lead wires by employing applicable connectors.
- THIS RETROFIT KIT IS ACCEPTED AS A COMPONENT OF A LUMINAIRE WHERE THE SUITABILITY OF THE COMBINATION SHALL BE DETERMINED BY AUTHORITIES HAVING JURISDICTION. Product must be installed by a qualified electrician in accordance with the applicable and appropriate electrical codes. The installation guide does not supersede local national regulations for electrical installation
- **Caution - risk of fire. Consult a qualified electrician to ensure correct branch circuit conductor.**

WHAT'S IN THE BOX

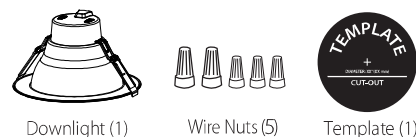

TOOLS NEEDED

This LED Recessed Kit requires very few tools for installation. A screwdriver and a pair of wirecutters will help to install.

OPTIONAL ACCESSORIES

Goof Ring



New construction plate for Stud/Joist

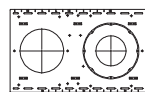

New construction plate for T-grid-Ceilings

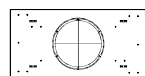

Installation With Existing Frame

1. Shut power OFF to the fixture.
2. Remove the old housing for lamp. (Fig. 1)

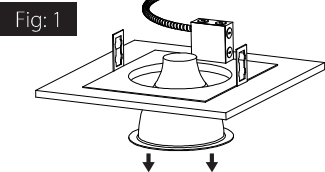

3. Attach the safety chain to the existing fixture housing. (Fig. 2)

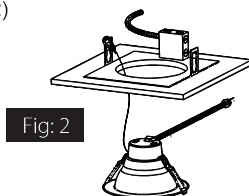

4. Remove junction box faceplate. Disconnect all wires to the ballast and remove ballast from J-Box. Remove appropriate knock out and attach the fixture conduit whip into the knock out. For 0-10V dimming circuits, connect Grey to Grey and Purple to Purple. Reattach J-Box faceplate.(Fig.3) Refer to wiring diagram for wiring connection (Dimming wires are optional)

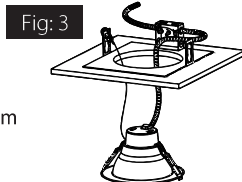

5. Adjust the fixture power to desire lumen output by sliding the back selector switch. Adjust the colour temperature to a desired one, by sliding the red selector switch. (Fig. 4)

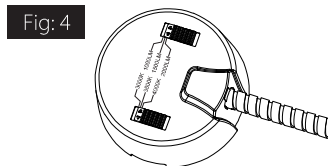

6. Install the downlight by lifting both spring clips upward. (Fig. 5)

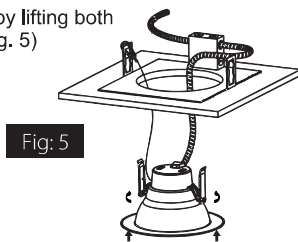

7. Push until the trim sits flush against the ceiling. (Fig. 6)

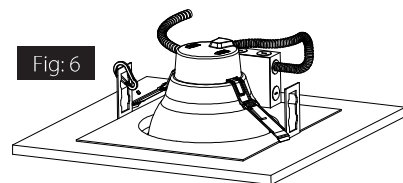

8. Restore power at the source and the installation is complete.



INSTALLATION INSTRUCTIONS FOR COMMERCIAL DOWNLIGHT

READ INSTRUCTIONS AND REVIEW ALL DIAGRAMS BEFORE INSTALLING THE FIXTURE. KEEP THESE INSTRUCTIONS FOR FUTURE REFERENCE.

Installation Without Existing Frame

1. Ensure POWER IS TURNED OFF at the source to the location in which you are installing the product.
2. Use template inside the box to cut a hole in the ceiling. (Fig. 7)

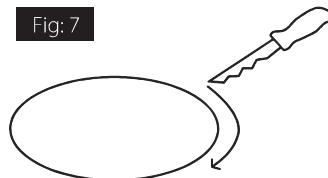

3. Select desired lumen output and CCT. (Fig. 8)

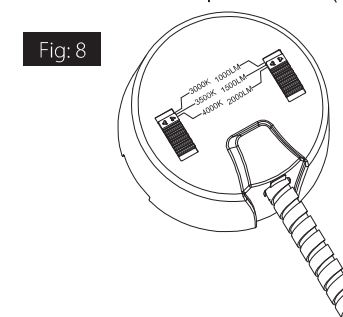

4. Insert lamp conduit into the preinstalled J-box (not provided) and wire to the power source (black to hot, white to neutral, green to ground). For 0-10V dimming circuits, connect grey to grey and purple to purple. Close the J-box securely. Install the downlight by lifting both retention tabs upward. (Fig. 9)

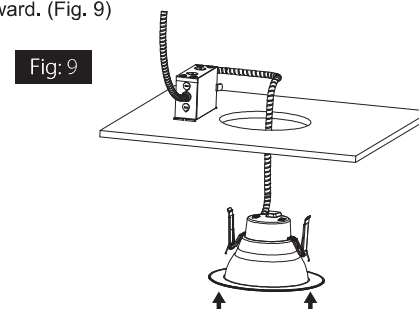

5. Push until the trim sits flush against the ceiling. (Fig. 10)

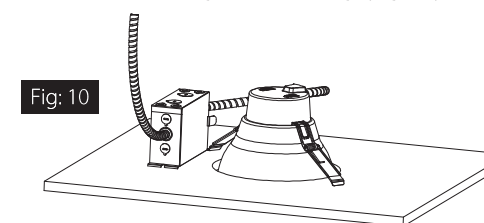

WIRING DIAGRAM

