

Pictures for illustration purpose only

Dimensions (mm)

Weight: 1.53 kg

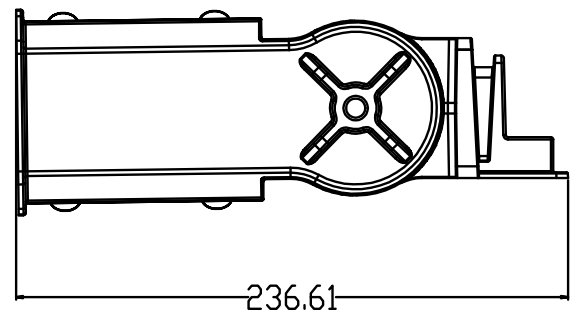
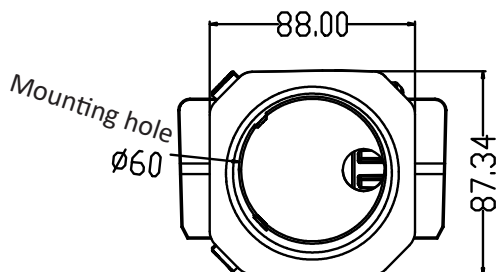
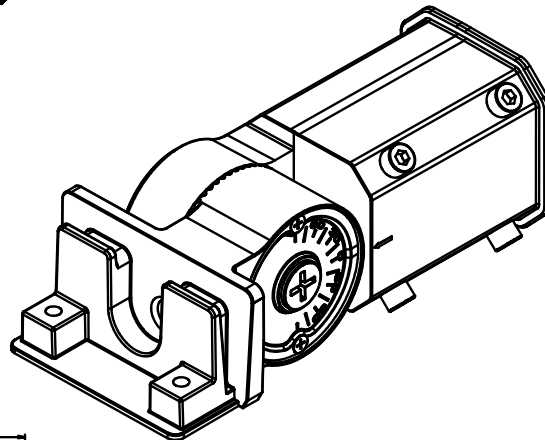
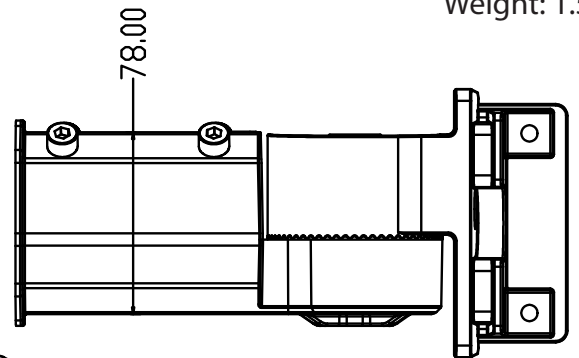
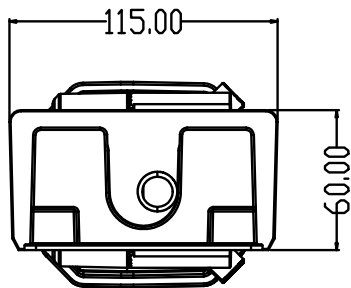

info@technilight.ca

WWW.TECHNILIGHT.CA