

## Explosion proof

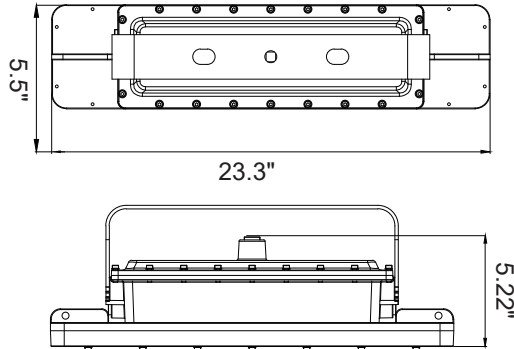

## Specifications TLLEP2C40H120P

### Electrical specifications

Model No.	TLLEP2C40H120P
Power (W) ± 10%	40 W
Input Voltage (V)	AC200-480V, 50/60Hz
Efficacy ± 3%	140 lm/W
Power Factor (PF)	0.9
Surge protection	N/D

### Photometric specifications

CRI	≥70
CCT	5 000 K
Beam angle	120°
Light Output ± 3%	5 600 lm
Dimmable	0-10 V

### Mechanical specifications

IP Rating	IP65
Material	Aluminum
Lens	Clear tempered glass
Net Weight	12 kg
Product size (mm)	± 584.2 x 127 x 126 mm
Product size (inch)	± 23.3" x 5.5" x 5.22"
Operating Humidity	N/D
Operating Temperature	-40°C ~ 60°C
Lifespan (L70)	>150 000 hours

## Product description:

- UL-844 Dangerous places  
CAN / CSA-C22.2 NO. 137  
CLASS 1 DIV 1 GROUP C, D  
CLASS 1 DIV 2 GROUP A, B, C, D  
CLASS 2 DIV 1 GROUP E, F, G  
CLASS 2 DIV 2 GROUP F, G  
CLASS 3
- Savings on energy consumption compared to HPS / MH lighting.
- Warranty: 5 years.
- Other CCT available on request.
- Color: Gray.

## Applications:

Areas with risk of explosion (gas emissions), areas with vapor or dust, petrochemical complexes, mines, etc.

Designed for wet locations.  
Indoor and outdoor.