

TPALUS300T4ABK

Technilight

PRO

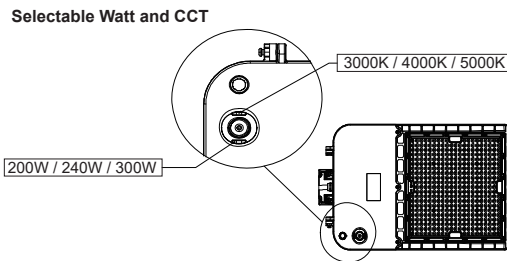
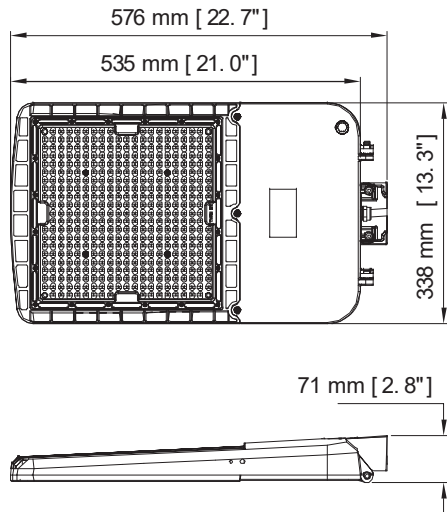

Specifications TPALUS300T4ABK

Electrical Specifications

Model No.	TPALUS300T4ABK
DLC ID	S-7MP3VN
Power selectable	200W / 240W / 300W
Input Voltage (V)	AC120-347V, 50/60Hz
Efficacy ± 3%	130.3 lm/W
Power Factor	0.937
Dimmable	0-10 V
Surge protection	6 kv
Total harmonic distortion	≤15%









Photometric Specifications

CRI	73
CCT selectable	3000K / 4000K / 5000K
Beam angle	Type IV
Light Output ± 3%	Min.: 26 060 lm Max.: 39 090 lm
BUG rating	B4-U3-G4

Mechanical Specifications

IP rating	IP65
Material	Aluminum
Lens	PC
Net Weight	4.88 kg
Product size (mm)	± 576 x 338 x 71 mm
Product size (in)	± 22.7" x 13.3" x 2.8"
Operating Humidity	10% - 90%
Operating Temperature	-40°C ~ 45°C
Lumen maintenance	>76% at 100 000 hours

Accessories (not included)

	Adjustable bracket for walls and square poles		Bracket for walls, square or round poles		"Slip fitter" bracket for 2 3/8 round poles
TPALPABK		TPALPMBK		TPALSFBK	
	Trunnion bracket		"U" bracket		Microwave motion sensor
TPALTRBK		TPALTU2BK		HD07VR-MH-BK	
	PIR motion sensor		Remote control for motion sensor		100-277V or 347V photocell kit
HD07VR-PH-BK		HD06R		TLPSK / TLHPSK	

Product description:

- Selectable power and CCT.
- Optional photocell.
- Optional motion sensor.
- Easily replace traditional MH or HPS luminaire fixture.
- Powerful light efficacy.
- Save in electricity consumption compared to fluorescent lighting fixture.
- Color: black.
Other colors available on request.
- Warranty: 5 years.

Applications:

Outdoor parking and wide area.

info@technilight.ca

WWW.TECHNILIGHT.CA